

Digital Key Telephone System

DV-22

Installation Manual



INTRODUCTION : 3

1. SYSTEM SUMMARY 4

 1.1 HARDWARE CONFIGURATION..... 4

 1.2 SYSTEM SOFTWARE 4

 1.3 SAFETY CONFORMITY..... 4

2. HARDWARE CONFIGURATION..... 5

 2.1 SYSTEM SPECIFICATIONS..... 5

 2.2 ELECTRICAL SPECIFICATIONS 6

 2.3 KEY TELEPHONE SPECIFICATION 7

 2.4 SYSTEM MODEL DESCRIPTION 8

 2.5 SYSTEM FEATURES LIST 9

 2.6 STATION FEATURES LIST..... 10

3. EQUIPMENT REQUIREMENT:.....11

 3.1 PREPARATION11

 3.2 ENVIRONMENT REQUIREMENT:11

 3.3 CABLE REQUIREMENT:.....11

 3.4 NOTICE:11

4. DV-22 PCB AND CABINET LAYOUT..... 13

 4.1 DV-22 SYSTEM DIAGRAM 13

 4.2 D4PWUA (FULL RANGE POWER ADAPTOR) 14

 4.3 D4MBUB(C) (MOTHER BOARD UNIT) 15

 4.4 D4TKUB (TRUNK UNIT) 16

 4.5 D4DLUB (KEY STATION CARD) 17

 4.6 D4SLCC (SLT STATION CARD) 18

 4.7 D4HYUB (HYBRID STATION UNIT) 19

 4.8 D4VSCA (VOICE SERVICE CARD)..... 20

 4.8 D4MFCA/B (MULTI FUNCTION CARD) 21

5. DV-22 PCB AND CABINET LAYOUT 22

- 5.1 POWER INSTALLATION 22
- 5.2 CO LINE INSTALLATION..... 23
- 5.3 STATION INSTALLATION 24
- 5.4 DOOR PHONE INSTALLATION 25
- 5.5 SENSOR INSTALLATION 26
- 5.6 DOOR SWITCH CONNECTION..... 27
- 5.7 EXTERNAL MUSIC INSTALLATION..... 28

INTRODUCTION :

Congratulations on your selection of the ARISTEL DV-22 SOHO System!

ARISTEL DV-22 is a state-of-the-art communication system that offers you unique features, flexibility and superb service in your office or in your home.

ARISTEL DV-22 system's digital technology extends well beyond handling just conventional phone calls. Computers, paging systems, fax machines, sensors, modems, door phones and even door latches can be connected and controlled through this unique system which is designed to suit your requirements today and grow with your business tomorrow.

The available capacity is 3-6 CO lines, 8-16 station ports together with a RS-232 port. Multi-function card ports such as door phone port, paging port, external music port, sensor and a switch are all powerful options to enhance your communication system.

This manual will provide you with detailed instructions and procedures for the successful installation of the ARISTEL DV-22 SOHO system. Please read this entire section before proceeding with the actual installation.

In case you have any other questions, please phone Aristel Tech Support.

1. System Summary

1.1 Hardware Configuration

- System capacity : 308~616
- **System Control** : Stored Program Control (SPC).
 - "A-SERIES_{6A}" ASIC IC
 - SMT interface agglutinate technology
 - Stationary trough interface installation, Main systematic and Internal/External Lines independent of each other

1.2 System Software

- Built-in programming : Store in ROM
- System Operation programming : Store in RAM
- Software Security Element : Watch Dog
- Programming security : Back up by "Li-Battery"
- Key phone operation security : Error operation recovery protection program.
- Extension Error Action Protection : Extension error action protection mode

1.3 Safety Conformity

- FCC、CE、AUSTEL、TAS、SIRIM
- Internal/External Lines Short Circuit Protection
- Power Mingled Dispatch Restraint
- Lightning Protection
- Power Fluid Transformation : AC110 ~ AC240
- KEY PAD Endurance : 1,000,000 Times

2. Hardware Configuration

2.1 System Specifications

The system uses fixed slot design - **all expansion cards have to connect to designated slots.**

DV-22	Basic Capacity	Expansion Capacity	Max. Capacity
CO Line	3	3	6
Key Telephone	8	6 / 8	16
Single Line Telephone	0	1 / 2 / 4 / 8	8
Door Phone Connection	0	1	1
Relay Interface	0	1	1
Sensor Interface	0	1	1
Auto Attendant	0	1 / 2	2
RS232 for SMDR	0	1	1
Speed Dial set	1000	0	1000
Power Failure Telephone interface	1	1	2
Virtual Extensions	16	-	16

2.2 ELECTRICAL SPECIFICATIONS

Input AC Voltage		AC110~240V
Power Consumption	Key Telephone	1~2 W
	Door Phone	0.5 W
	Maximum	40 W
System Power Back-Up Battery		4 ~ 5 Hour (24 V 7AH)
Loop Resistance	CO Line	1.5K Ω max.
	Key Telephone	40 Ω max.
	Door Phone	40 Ω max.
Dialing Signal	Outgoing Dialing	Tone / Pulse
	Intercom Dialing	Tone / Pulse / Digital
Wiring Installation	CO Line/Key Telephone	2 wires
	Door Phone	2 wires
	Relay Switch	2 wires
	External Music/paging	2 wires
Relay Switch	Type	SPDT
	Contact Capacity	120V x 7A max.
System Dimension (mm, WxDxH)		310 x 205 x 70 mm
Key Telephone Dimension (mm)		200L x 180W x 75H mm
Working Temperature		0 $^{\circ}$ C ~ 45 $^{\circ}$ C (32 $^{\circ}$ F ~ 113 $^{\circ}$ F)
Working Humidity		10% ~ 90% relative non-condensing

2.3 KEY TELEPHONE SPECIFICATION

Model	DKP70X	DKP73	DKP51	DKP53
Flexible DSS Key	10 Keys	20 Keys	20 Keys	20 Keys
LCD (16 x 2)	...	✓	Large LCD	Large LCD
Handsfree Dialing	✓	✓	✓	✓
Direct Intercom dialing	✓	✓	✓	✓
Optical hook switch	✓	✓	✓	✓
Dual Color LED indicator	10 Keys	20 Keys	20 Keys	20 Keys
Digital Volume Control	8 levels	8 levels	8 levels	8 levels
Short-circuited Protection	✓	✓	✓	✓
Handsfree Conversation	...	✓	...	✓
One-Touch Paging	✓	✓	✓	✓
Last outgoing Redial	✓	✓	✓	✓
Calculator	...	✓	✓	✓
Individual Speed Dial	20 sets	20 sets	20 sets	20 sets
Different Ringing Frequencies	9 selections	9 selections	9 selections	9 selections

2.4 System Model Description

Model No.	Description
D4-308K	MAIN SERVICE UNIT , consisting of (Plastic Cabinet + D4MBUA + A7PWUA)
D4PWUA	POWER UNIT
D4MBUA	MOTHER BOARD UNIT , consisting of (3 CO Lines + 8 Digital Key Stations Ports)
D4MBUB	MOTHER BOARD UNIT , consisting of (3 CO Lines + 8 Digital Key Stations Ports), with RS-232 interface.
D4TKUB	CO Trunk CARD , consisting of 3 CO Lines
D4DLUB	Key Station Card , consisting 8 Digital Key Station Ports.
D4HYUB	HYBRID STATION UNIT , consisting of 6 Digital Key Station+2 SLT Station port)
D4SLUB	SLT STATION CARD , consisting of 8 SLT Station Ports
D4SLCC	SLT STATION CARD , consisting of 4 SLT Station Ports
D4SLCD	SLT STATION CARD , consisting of 1 SLT Station Ports
D4VSCA	VOICE SERVICE CARD , consisting of 2 Voice Channels (60 seconds)
D4VSCB	VOICE SERVICE CARD , consisting of 1 Voice Channel (60 seconds)
D4VSCC	VOICE SERVICE CARD , consisting of 2 Voice Channels (60 seconds) with Fax Detection function
D4MFCA	MULTI FUNCTION CARD , consisting of (1 Sensor + 1 Relay + 1 Door Phone Port)
D4MFCB	MULTI FUNCTION CARD , consisting of 1 Door Phone Port
D1CIDC	FSK/DTMF CLI INTERFACE

2.5 System Features List

- 2 Pages of DSS Keys
- 5 Different Trunk Access Codes
- 9 Different Incoming Ringing Frequencies
- Account Code
- ❖ Auto Attendant
- Auto Accessing Trunk
- Automatic Answer (Intercom)
- ❖ Automatic Call Distribution (ACD)
- Automatic Transfer
- ❖ Baby Listening
- ❖ Caller's Number Identification
- Call Limit Time Duration
- Call Park
- Call Split
- Console Grouping
- Date/Time Setting
- Day/Night Schedule
- Direct Intercom Dialing
- Direct Inward Station Access (DISA)
- ❖ Door Phone Connection
- ❖ Door Switch Control
- ❖ Environment Monitor
- ❖ Fax Call Detection
- Flexible Function Key Assignment
- Forced Account Code
- Headset Function
- Hot Line
- Illegal Outgoing Prohibit
- Intercom Busy Reminder
- Incoming Hunting
- Incoming Paging
- Intercom Hunting
- Internal/External Music Source
- Internal/External Paging
- Key Station Short Protection
- Lightning Protection
- Message Waiting
- Name Speed Dialing (Phone Book)
- One Touch Operation
- Power Failure Telephone
- Private Line
- Programming Help List
- ❖ Remote Programming
- ❖ Remote Relay Control
- ❖ Security/Fire Alarm System
- Single Digit Dialing
- ❖ Station Loud Bell
- ❖ Station Message Details Report (SMDR)
- System Alarm
- Toll Restriction
- Tone/Pulse Dialing
- Trunk Grouping
- ❖ Trunk Loud Bell
- Trunk Queuing

❖ Means the optional function.

2.6 Station Features List

- 16×2 Dot-Matrix LCD Display
- 5 Different Numbers Auto Redial
- 9 Different Ringing Frequencies on Key Station
- Adjustable LCD Angle
- Built-In Calculator Function (25 Buttons LCD Phone)
- Call Forward/Call Follow Me
- Call Forward To Individual Speed Dial
- Call Pick Up
- Call Transfer
- Camp On
- Day/Night Service Indication
- Digital Volume Control (8 Levels)
- Do Not Disturb
- Dual-Color/Tri-Status BLF Indication
- ❖ DSS Console
- Handsfree Dialing
- ❖ Handsfree Conversation
- Hold/Exclusive Hold
- Last Outgoing Redial
- Macro Key Setting
- Message Text
- Monitor
- Override
- Page/Be Paged
- Station Lock/Unlock
- Station Name Setting
- Station Operation Help List

❖ means the optional function.

3. Equipment Requirement:

3.1 Preparation:

- ◆ Survey the capacity of system and telephone.
- ◆ Survey the wiring and terminals.
- ◆ Carefully study and follow this manual before installation.

3.2 Environment Requirement:

- ◆ Input Voltage : AC110~240V

System Power Back-up Battery : Connect with DC24V power source to the battery back-up interface to ensure a continuous supply of power during a power failure.

3.3 Cable Requirement :

CO Line : 2 wires

Key Telephone : 2 wires

SLT : 2 wires

Door Phone : 2 wires

Relay Switch / Sensor : 2 wires

External Paging / External music : 2 wires

3.4 Notice:

The main unit should be installed in a clean, dry, dust-free and secure location. Place at least 10cm above the ground to avoid vibration.

Install in a well ventilated environment and away from direct sunlight.

Install main unit in the center position of the extensions to shorten the distance between main unit and extensions.

- ◆ The power supply must be independent from the others. And keep away from high frequency sources and noise to avoid interference from EMI.

- ◆ Use three-aperture outlet. (Include ground connection)
- ◆ Install lightning rod ground wire to ensure stability of system.
- ◆ Use twin wire to avoid noise and interference when the wiring is too long.
- ◆ Keep away from the power cord and interference source. Otherwise, it's necessary to use segregated wire and install a ground wire.

4. DV-22 PCB AND CABINET LAYOUT

4.1 DV-22 SYSTEM DIAGRAM

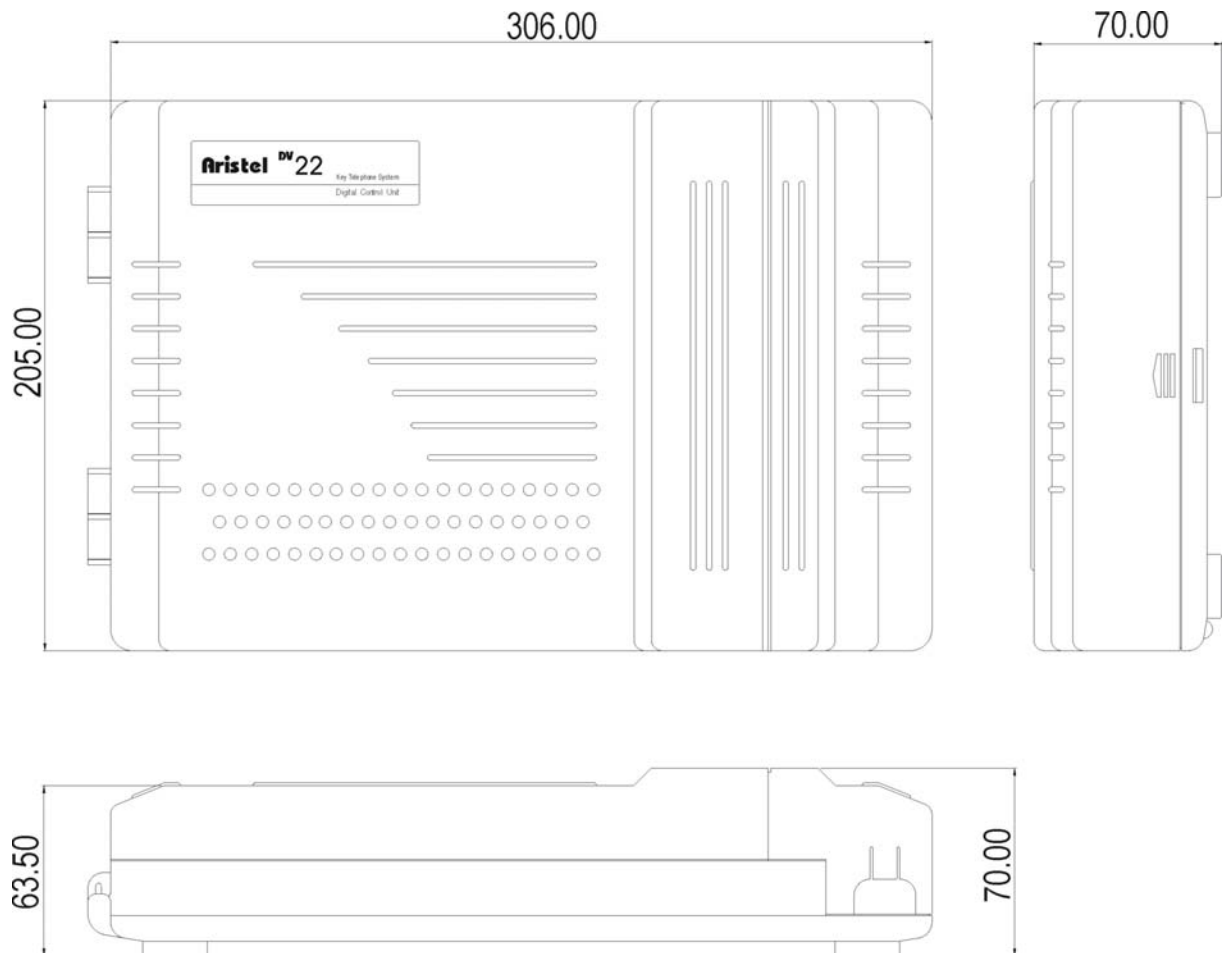

Figure 1: DV-22 Diagram

1. System Dimension : 306 x 205 x 70mm
2. System AC Input : 110~240VAC
3. External Backup Battery Input : 24VDC

4.2 D4PWUA – Full Range Power Adaptor



Figure 2: DV-22 power adaptor D4PWUA front view

1. AC Input : 110~240VAC Full range
2. DC Output : 28VDC

4.3 D4MBUB(C) (Mother Board Unit)

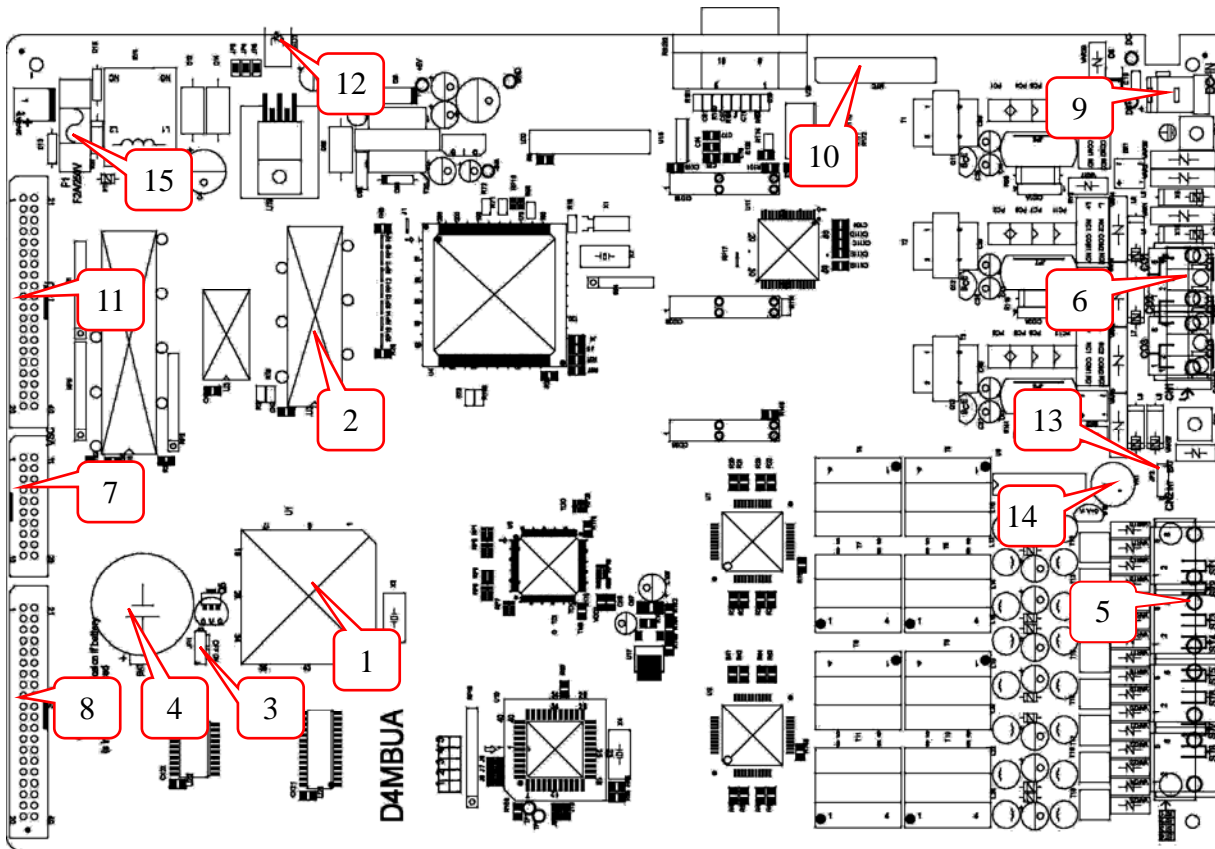

Figure 3: DV-22 Mother board Unit (D4MBUB)

1. CPU
2. System Software EEPROM
3. System Software RAM backup battery Switch
4. System Software RAM backup battery
5. Key phone port connector
6. Trunk port connector
7. D4VSCA card connector
8. Standard card expansion connector
9. D4PWUA power adapter connector
10. D4MFCA/D4MFCB Multi-function card connector
11. D4TKUA trunk expansion connector
12. System working Indicator
13. Music on hold Switch (Internal/ External)
14. The volume controller of the Internal Music on hold
15. Battery Reverse Protect Fuse: 2A/250V

4.4 D4TKUB (Trunk Unit)

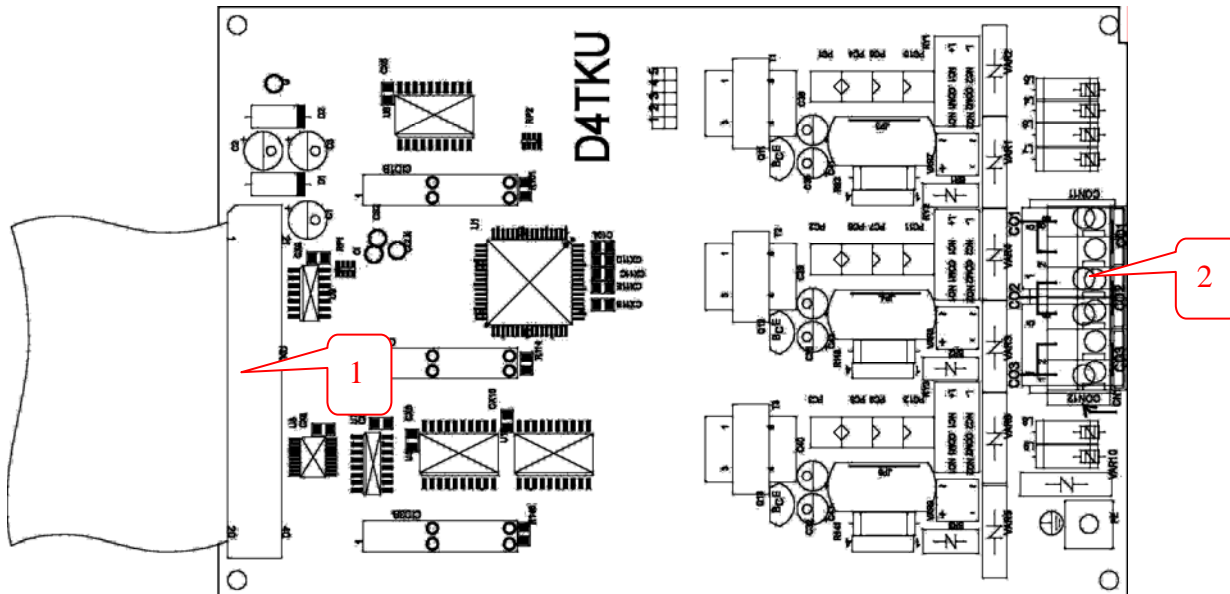

Figure 4: DV-22 CO Trunk Card Unit (D4TKUB)

- 1. For D4MBUB connection.
- 2. **RJ-12 Connectors** for CO Line Connection

NOTE : D4TKUB (CO Trunk CARD) consists of 3 CO Lines

REFER TO PAGE 23 FOR CONNECTION DETAILS

4.5 D4DLUB (Key Station Card)

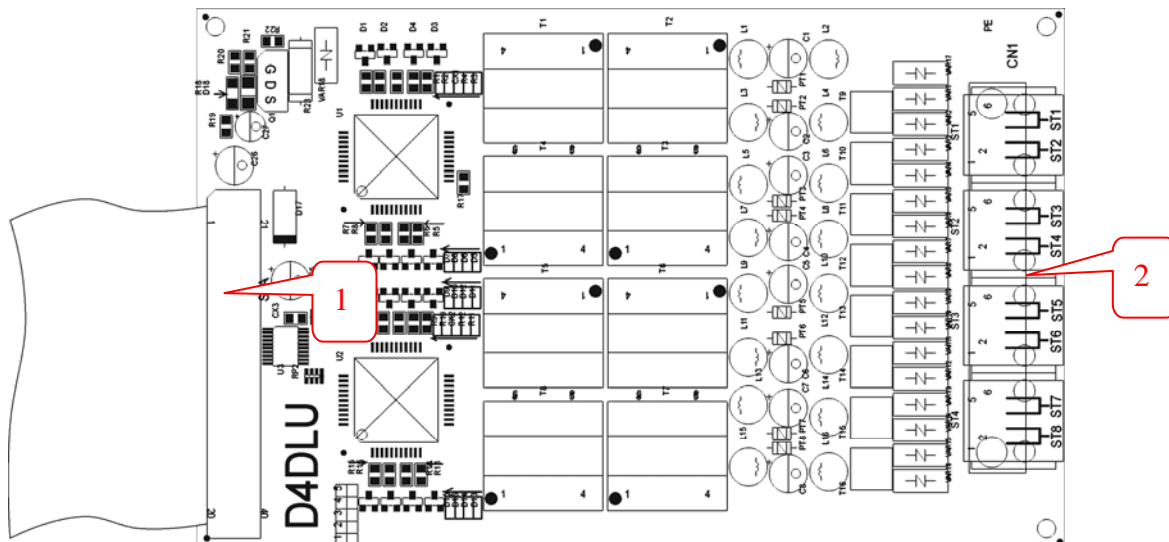

Figure 5: DV-22 Key Station Card Unit (D4DLUB)

1. For D4MBUB connection.
2. Quick-Connector Module for **Key phone connection, (Use 2-wire T/R)** , including 4 sets of 6 wires RJ-12 Connector.

NOTE : D4DLUB (Key Station Card) consists of (8 Digital Key Station Ports)

REFER TO PAGE 24 FOR CONNECTION DETAILS

4.6 D4SLCC (SLT Station Card)

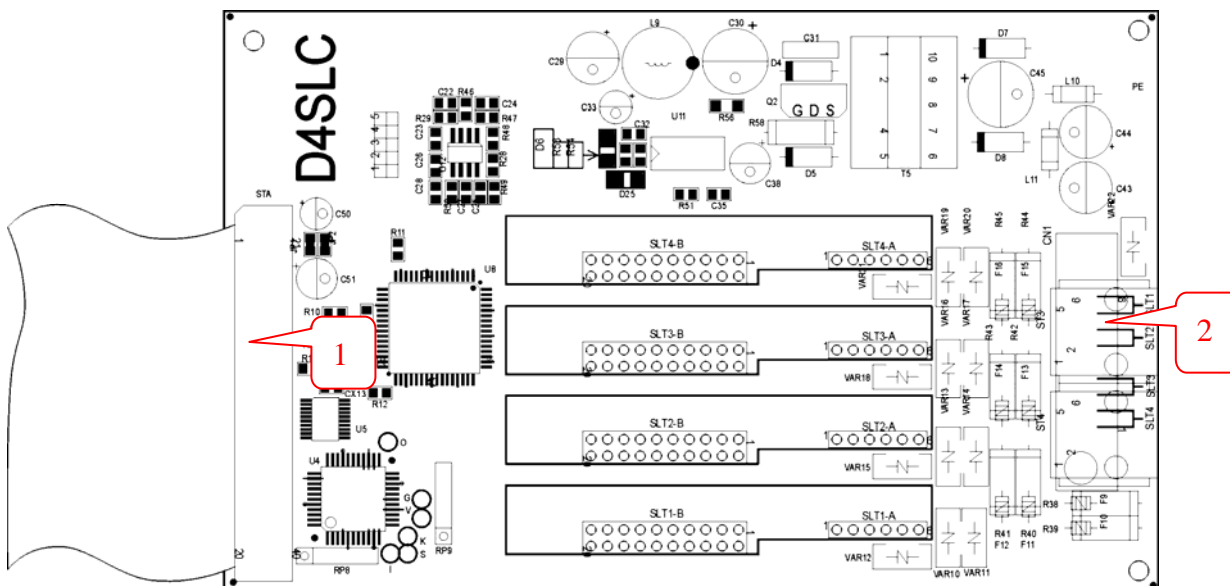

Figure 6: DV-22 SLT Station Card Unit (D4SLCC)

- 1. For D4MBUB connection.
- 2. Quick-Connector Module for **Single Line phone connection (Use 2-wire T/R)** , including 2 sets of 6-wire RJ-12 connector.

NOTE : D4SLCC (SLT Station Card) consists of 4 SLT Station Ports.

D4SLCD (SLT Station Card) consists of 1 SLT Station Port.

4.7 D4HYUB (Hybrid Station Unit)

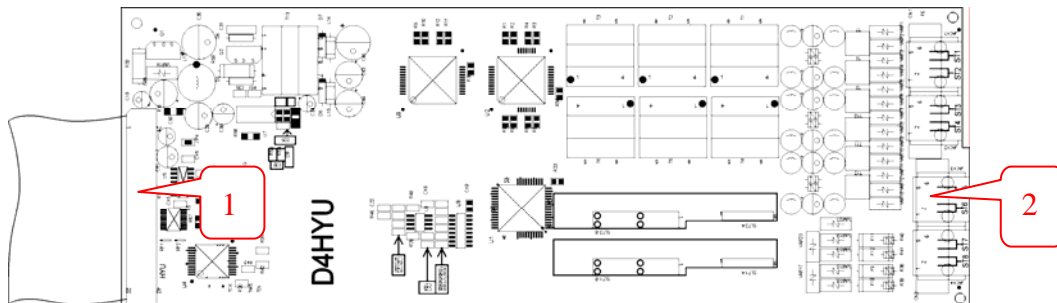

Figure 7 : DV-22 Hybrid Station Unit

- 1. For D4MBUB connection.
- 2. Quick-Connector Module for **Key Station Wiring**, or **Single Line Telephone (Use 2-wire T/R)**, including 4 sets of 6-wire RJ-12 connector.

NOTE : D4HYUB (Hybrid Station Unit) consists of 6 Digital Key Station + 2 SLT Station ports.

4.8 D4VSCA (Voice Service Card)

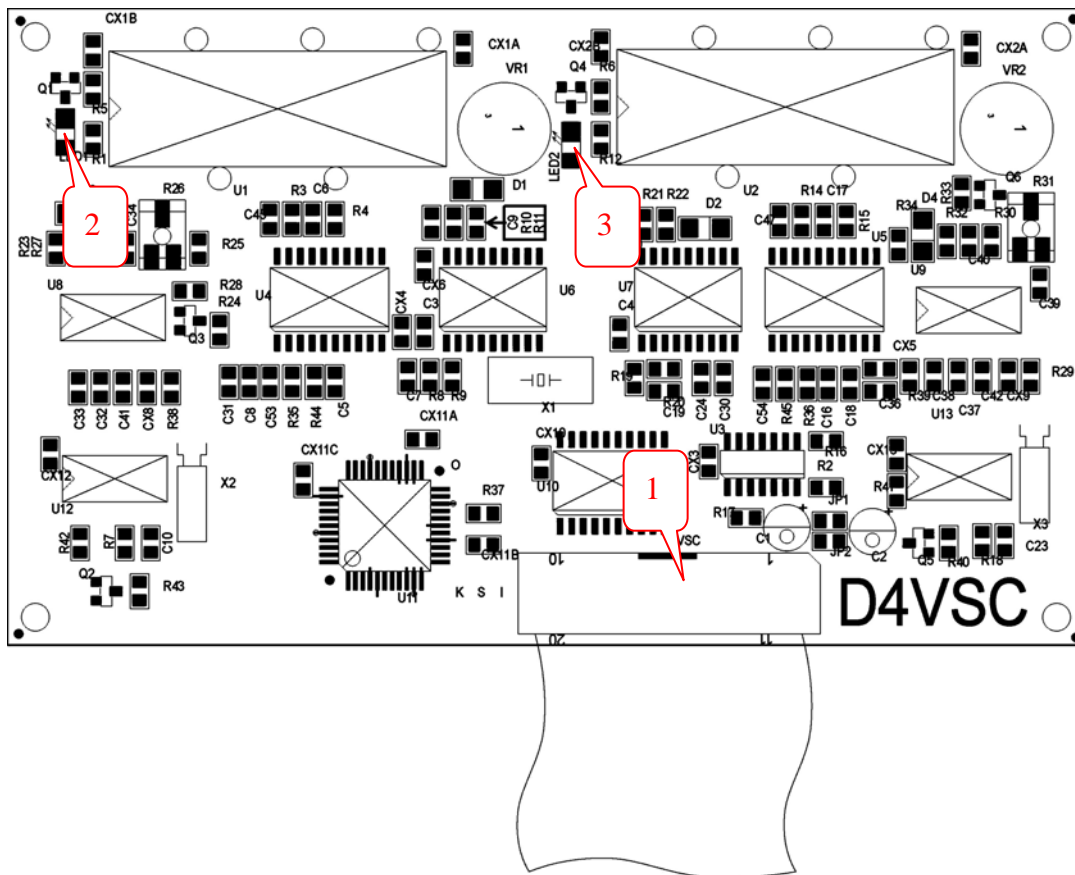

Figure 8: DV-22 Voice Service Card (D4VSCA/B)

1. For **D4MBUB** connection.
2. LED : To indicate the **channel 1** is working when LED is blinking.
3. LED : To indicate the **channel 2** is working when LED is blinking.

NOTE : D4VSCA (Voice Service Card) consists of 2 voice channels (60 seconds per channel)
 D4VSCB (Voice Service Card) consists of 1 voice channels (60 seconds per channel)
 D4VSCC (Voice Service Card) consists of 2 voice channels (60 seconds per channel) with Fax detection function

4.9 D4MFCA/B (Multi Function Card)

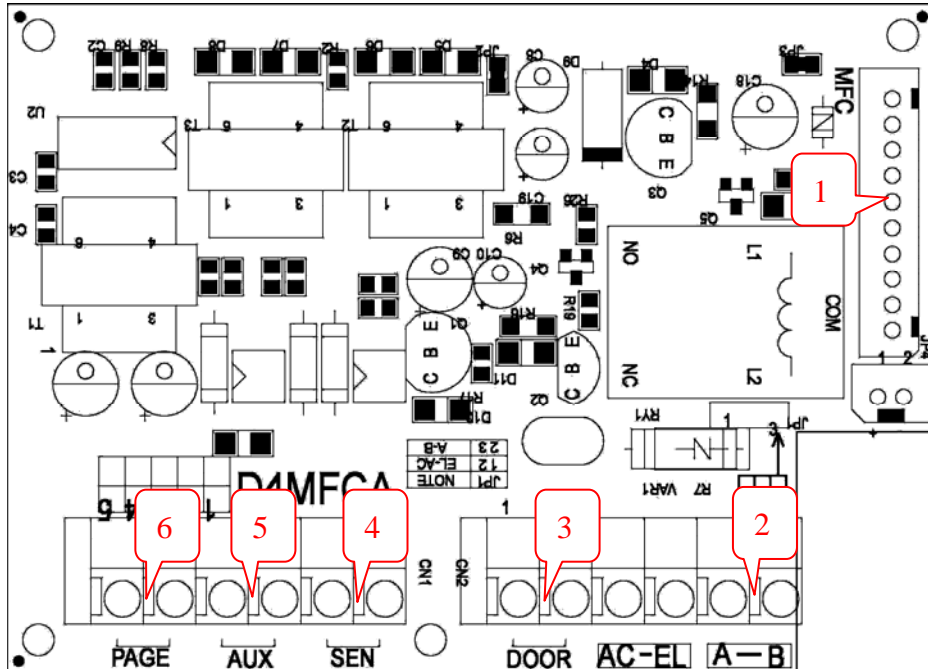

Figure 9 : DV-22 Multi Function Card (D4MFCA/B)

1. For D4MBUB connection.
2. **A-B**: Terminal-Block Connector, for the Relay Connection.
3. **DOOR**: Terminal-Block Connector, for the Door Phone Connection.
4. **SEN**: Terminal-Block Connector, for the Sensor Connection.
5. **AUX**: External music input connector
6. **PAGE**: External page output connector

NOTE : D4MFCA (MULTI FUNCTION CARD), consists of (1 Sensor + 1 Relay +1 Door Phone Port + External Music Source).
D4MFCB (MULTI FUNCTION CARD), consists of (1 Door Phone Port).

5. INSTALLATION AND WIRING

5.1 POWER INSTALLATION

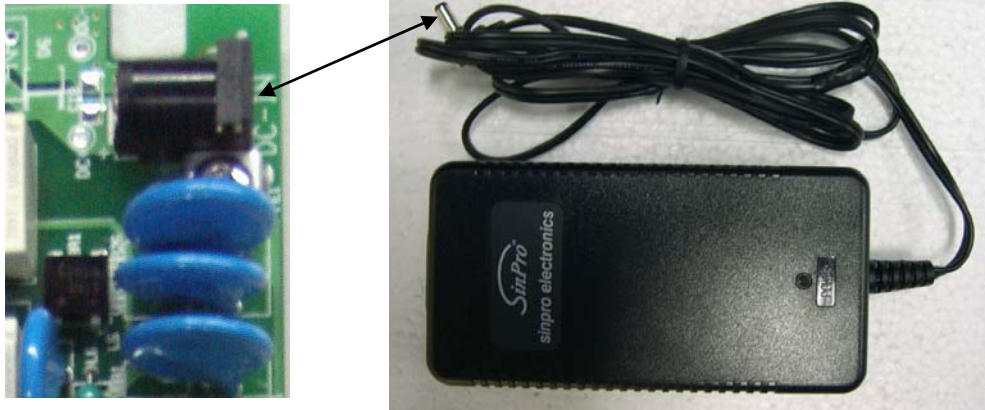
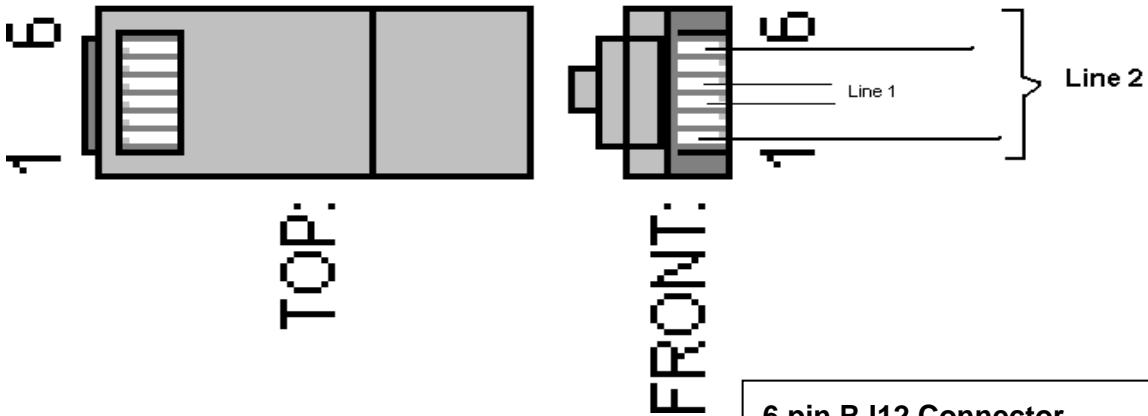
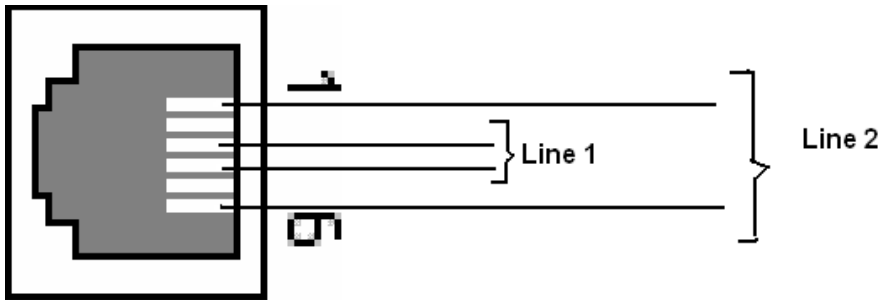

Figure 10 : DV-22 Power Installation

5.2 CO LINE INSTALLATION

RJ12 Socket



6 pin RJ12 Connector
pins 3 & 4 for Line 1, pins 1 & 6 for Line 2

4 pin RJ12 Connector
pins 3 & 4 for Line 1, pins 2 & 5 for Line 2



Figure 11: CO line installation

WARNING: Do not use 4 wire telephone line cord to connect CO lines straight into RJ12 socket – use 2 wire line cord

5.3 STATION INSTALLATION

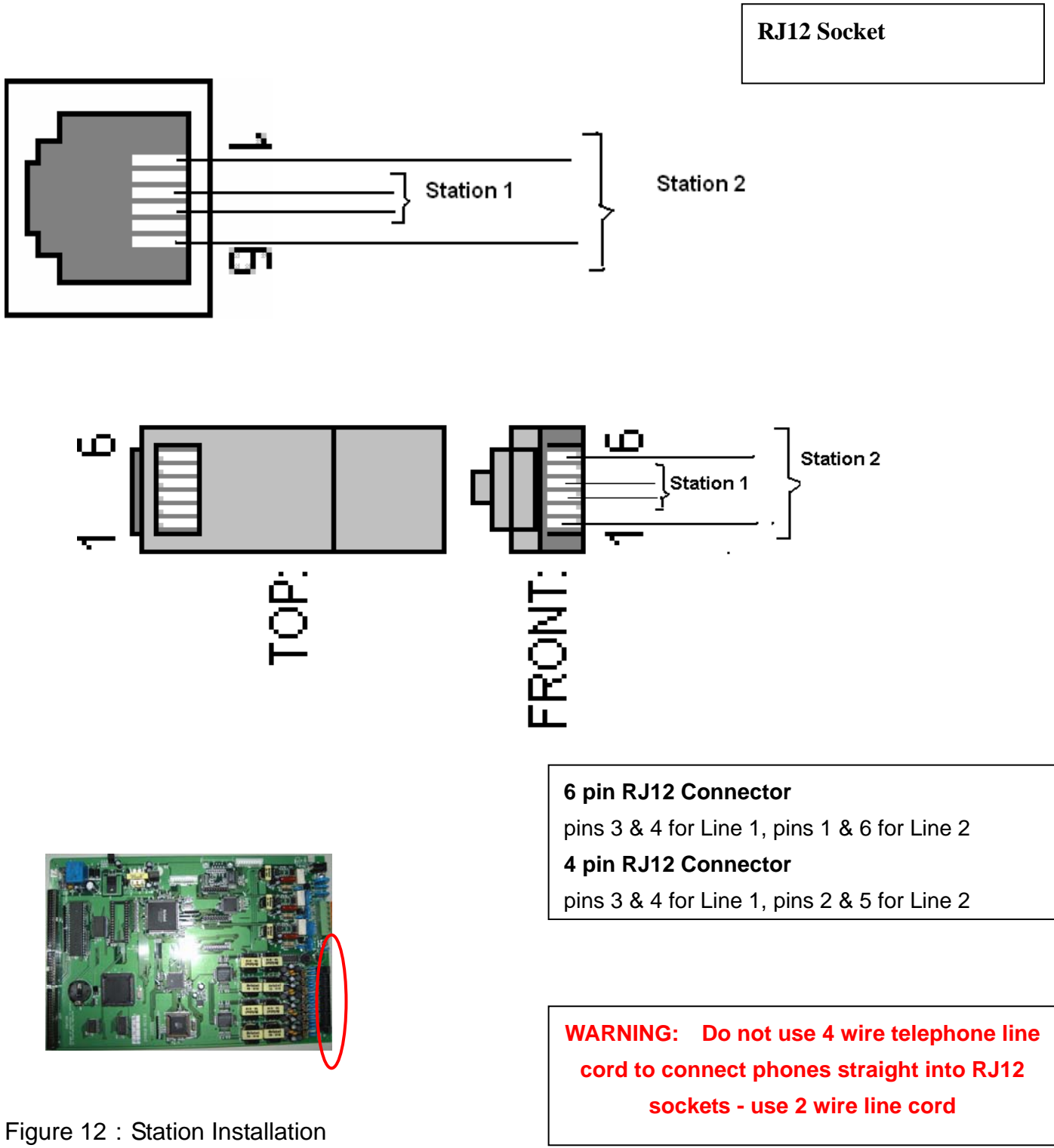

Figure 12 : Station Installation

5.4 DOOR PHONE CONNECTION

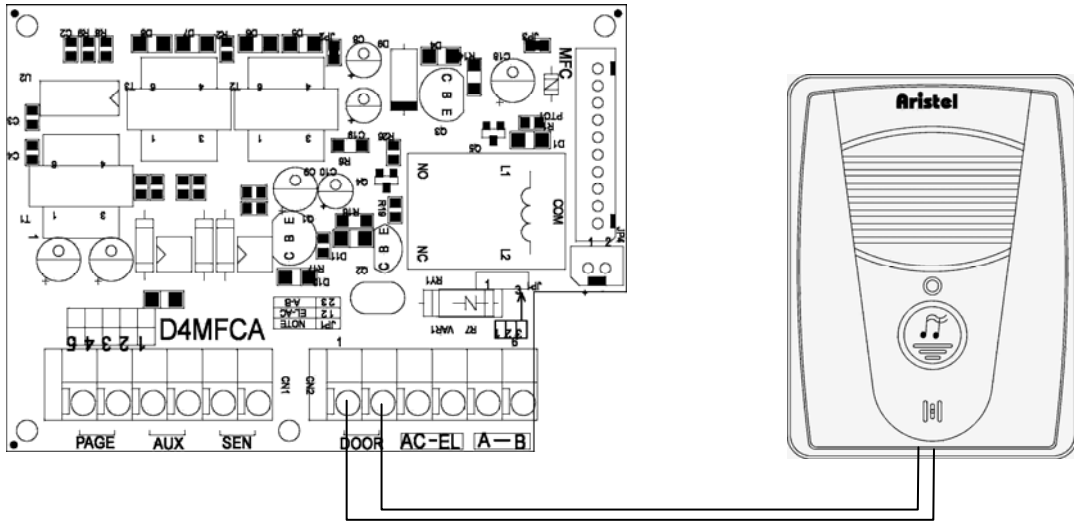

Figure 13: Door phone installation

5.5 SENSOR INSTALLATION

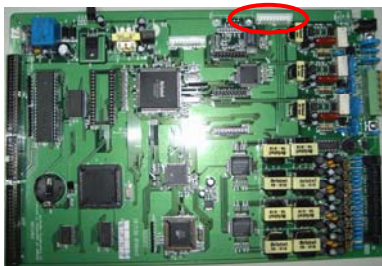
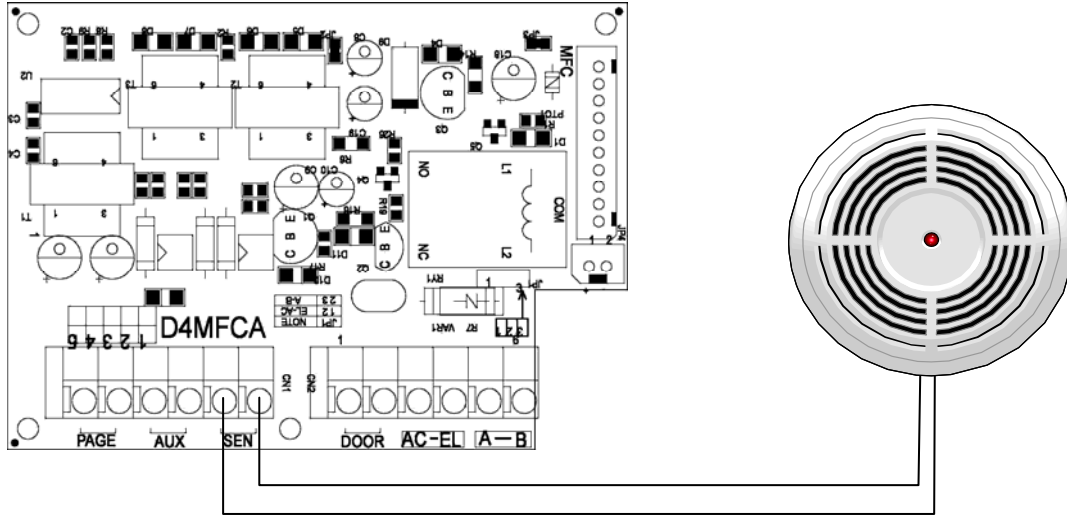

Figure 14: Sensor installation

5.6 DOOR SWITCH CONNECTION

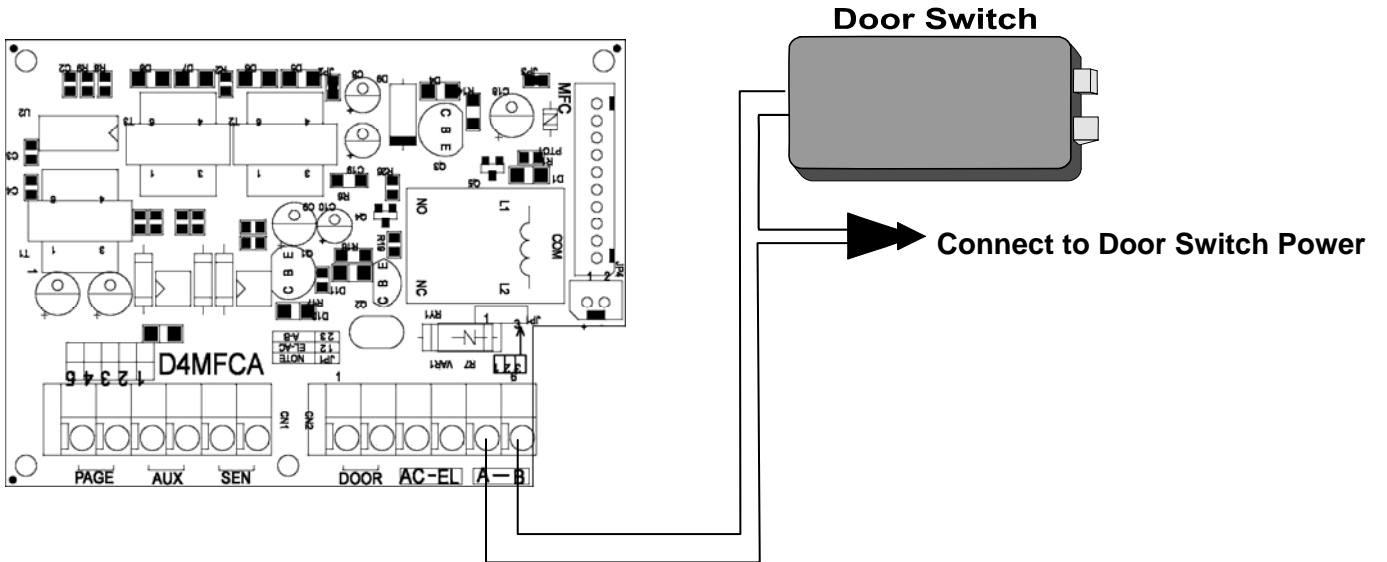

Figure 15: Door switch installation

5.7 EXTERNAL MUSIC INSTALLATION

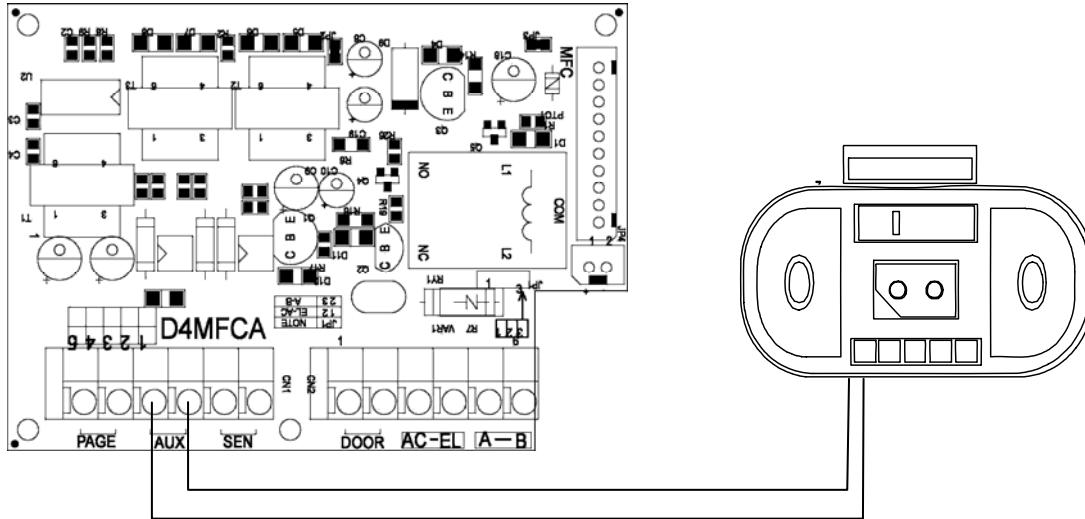

Figure 16: External music installation

IMPORTANT HELP NOTES

HELP NOTE # 38

HELP NOTE TITLE:- DV22 system

The DV22 introduced in Nov 2007 is a compact digital system with a maximum of 22 ports. The available capacity is 3-6 Co lines and 8-16 station ports. In addition there are 16 virtual extensions. The **Motherboard** occupies the lower deck whereas expansion cards are fixed on the upper deck.

Programming aspects of DV22 are similar to earlier Aristel systems but with minor changes.

Multifunction card has a dedicated position on the upper deck. It has two green blocks for connections. The first green block has connections for (i) **Paging**, (ii) **MOH**, marked AUX and (iii) **Sensor**. The second green block has connections for (i) **Door phone** (ii) Normally Open Switch contact with 24V in series and (iii) **Normally Open Switch** contact.

WARNING: Item (ii) of the second green block should not be used for door latch release as such devices draw a very high current.

The **Voice Service Card** D4VSCD has two voice channels with **FAX detection capability**. The following example shows how to program Fax detection.

```
Z600, Co1, item01= 11, 12, 13
Z118 = 004 Ring the extensions for 4 sec
Z604, Co=01, item03=3 DISA activated for Day and Night
Z400, Group=07, item 03=21 where 21 is the fax extension
Z220=01 default 01 , enable fax capability
```

ONLY ONE station card, whether it is an SLT card or a Digital station card can be installed on the left hand side of the upper deck, marked "HYBRID CARD". **ONLY ONE** trunk card can be installed on the right hand side of the upper deck, marked "---- CARD".

IMPORTANT NOTE: There are many types of station cards ranging from single station to 8 stations available. However, **ONLY ONE** card can be installed in an expansion card position. Therefore, it is important to consider the future expansions very seriously before ordering a station card.

Transmission level on trunk lines.

WARNING: Do not adjust transmission levels unless it is absolutely necessary.

1. Zone 612_CO:xx = "0"~"4" - TX speech level adjust; default is "0" disable and can be increased from "1"/1dB up to "4"/+4dB.
2. Zone 613_CO:xx = "0"~"4" - RX speech level adjust; default is "0" disable and can be increased from "1"/1dB up to "4"/+4dB.

The above setting also effects the DTMF signaling, the DTMF sending level increase as well.

Virtual Extensions, 16 of them are very useful for abbreviated dialing and easy to program. The following example shows how to program a virtual extension 55

```
Z258, Times=06 Enable virtual extensions
Z610 , DID=83 EXT= 055 - i.e. extension 55
Z404, SPD= 283, item01 = xxxxxxxxxx - program speed dial number in bin 283
When you dial 55 from internal extension or via DISA the call will be forwarded to the mobile phone.
Z225, #0
```

Note: All SLT on DV22 receive CLI & MW
EnGenius cordless will display CLI when ZONE 502 item 06 = 4 is programmed
Fax detection capability only works if D4VSCD is installed and DISA activated (Not call queue)

DOC : DV-22 Installation Manual

Edition Version: 1.1

Part No.: 72000686

Editor :

Date : 12 December 2007

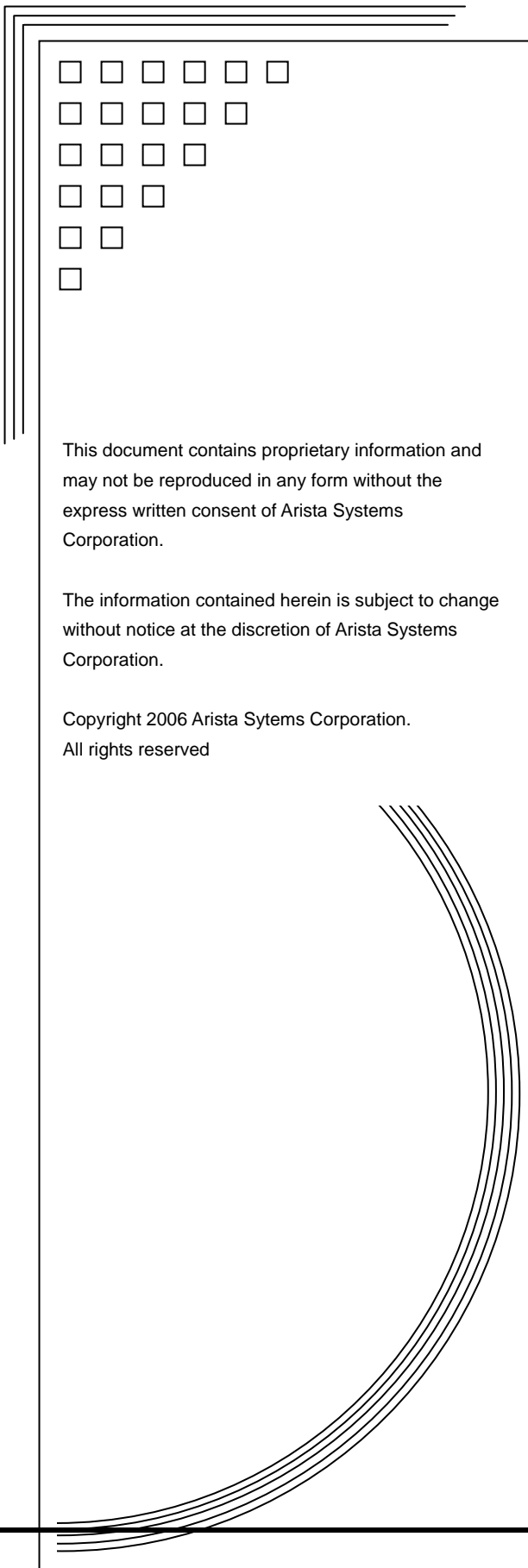

This document contains proprietary information and may not be reproduced in any form without the express written consent of Arista Systems Corporation.

The information contained herein is subject to change without notice at the discretion of Arista Systems Corporation.

Copyright 2006 Arista Systems Corporation.
All rights reserved